

# Roger™ Touchscreen Mic

Quick setup guide | Schnellstartanleitung

Guide d'installation rapide | Guía rápida de instalación



röger



**PHONAK**  
life is on

Device description  
 Produktbeschreibung  
 Description de l'appareil  
 Descripción del dispositivo

- ① On/Off
- ② Wake/sleep  
 Ein/Aus Standby  
 Marche/veille  
 Activación/reposo

- ③ Indicator light  
 Statusanzeige  
 Témoin lumineux  
 Indicador luminoso

- ④ Microphones  
 Mikrofonen  
 Microphones  
 Micrófonos

- ⑤ Mute  
 Stumm  
 Mode sourdine  
 Modo silencio

- ⑥ Touchscreen display  
 Touchscreen Bildschirm  
 Ecran Touchscreen  
 Pantalla Touchscreen

- ⑦ micro-USB
- ⑧ Jack 3.5 mm / 1/8"

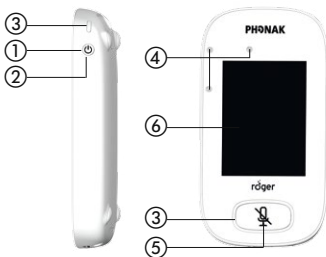

Device description  
 Produktbeschreibung  
 Description de l'appareil  
 Descripción del dispositivo

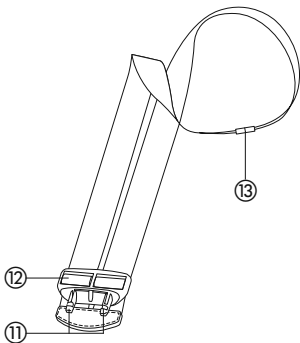
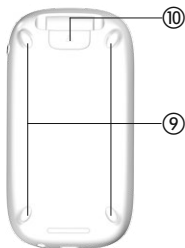

- ⑨ Feet  
Füße  
Pieds  
Pies
- ⑩ **Lanyard:**  
Clip/remove button  
Ein-/Aus-Taste  
Bouton mettre/enlever  
Botón encender/apagar
- ⑪ Lanyard clip
- ⑫ Length adjustment  
Länge einstellen  
Ajustement longueur  
Ajustar longitud
- ⑬ Safety breakaway  
Sicherheitsverschluss  
Bouton de sécurité  
Botón de seguridad

Components  
Komponenten  
Composants  
Componentes



Roger Touchscreen Mic

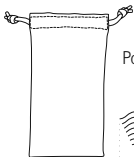

Pouch | Beutel | Poche | Bolso

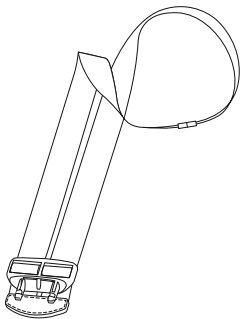

Lanyard

Package contents may vary slightly depending on country.  
Der Lieferumfang kann je nach Land variieren.  
Le contenu peut varier selon les pays.  
El contenido puede variar dependiendo del país.

Charging  
Aufladen  
Charger  
Cargar

A

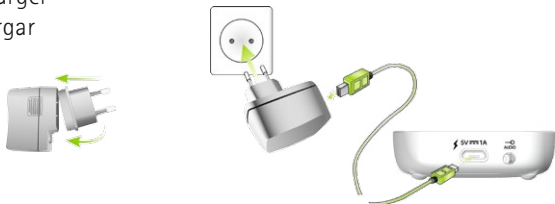

B



C

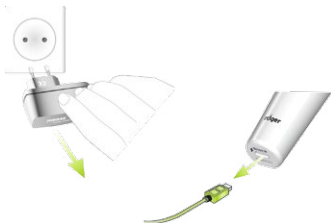

Switching On/Off  
Ein-/Ausschalten  
Mise en marche/éteindre  
Encender/apagar



Mute  
Stumm  
Sourdine  
Silenciar



Touchscreen display  
Touchscreen Bildschirm  
Ecran Touchscreen  
Pantalla Touchscreen



Connecting  
Verbinden  
Connecter  
Conectar

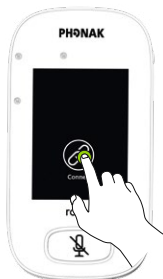

Distance  
Distanz 0-10 cm  
Distance 0-4 inches  
Distancia

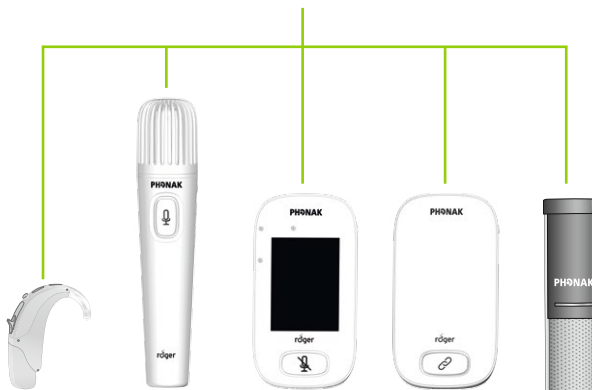



Sleep  
Stand-by  
Veille  
Reposo

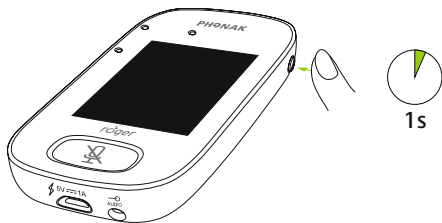

Wake  
Ein  
Marche  
Activación

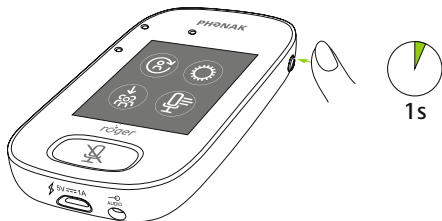

Microphone usage  
 Als Mikrofon verwenden  
 Utilisation comme microphone  
 Utilizar como micrófono



Microphone mode	
Automatic	✓
Small Group	
Pointing	
Lanyard	



Small Group

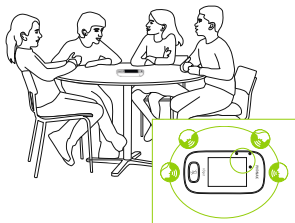

Pointing

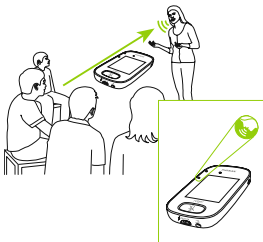

Lanyard

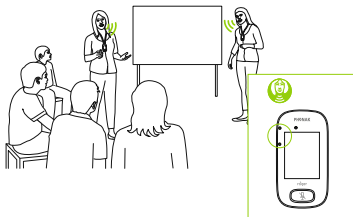

Lanyard: How to use

Lanyard: Wie benützen

Lanyard: Comment utiliser

Lanyard: Como utilizar

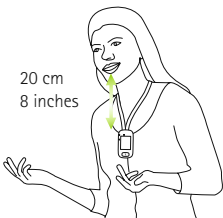
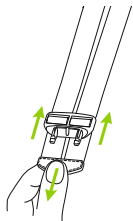
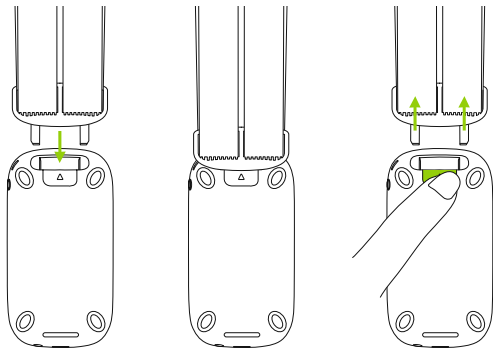

Recording: How to use  
Aufnahme: Wie benützen  
Enregistrement: Comment utiliser  
Grabación: Como utilizar

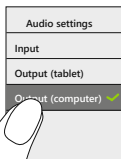
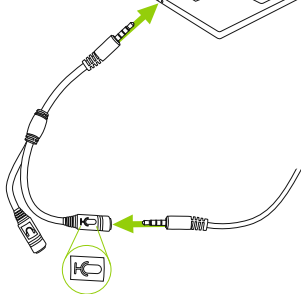
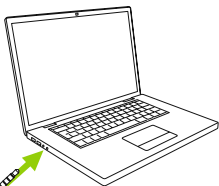



Indicator light  
Statusanzeige  
Témoins lumineux  
Indicador luminoso



On/Off



Charging | Aufladen | Charge | Cargar



Fully charged | Voll aufgeladen |  
complètement chargé | Completamente cargado



Mute | Stumm | Mode sourdine | Modo silencio



Primary not available | Primary nicht verfügbar |  
Primary indisponible | Primario no disponible



On/Off



Charging | Aufladen | Charge | Cargar



Fully charged | Voll aufgeladen |  
complètement chargé | Completamente cargado



Switched on | Eingeschaltet | Allumé | Encendido



Recharge device | Gerät aufladen | Recharger appareil |  
Cargar dispositivo



Symbols  
Symbolen  
Symboles  
Símbolos



Battery status – Charging – Low



Remaining time for use | Restnutzungsdauer |  
Temps d'utilisation restant | Duración restante de  
utilización



Microphone mode: Lanyard/Small Group/Pointing



Network, SubNet



MTN mode = Primary Talker or Equal Talker



Audio – Input/Output/Boom



USB



MTN role = Stand-alone/Primary/Secondary



Screen progress



Quick view



Operation range  
Betriebsreichweite  
Plage de fonctionnement  
Alcance en funcionamiento

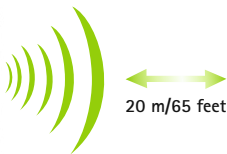

Receivers | Empfänger  
Récepteurs | Receptores  
Microphones | Mikrofone  
Microphones | Micrófonos



Out of range! If distance greater than 20 meters / 65 feet  
Ausser Reichweite! Wenn der Abstand größer als 20 Meter ist  
Hors de portée! Si distance supérieure à 20 mètres  
¡Fuera de alcance! Si la distancia es mayor que 20 metros

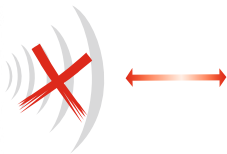

Receivers | Empfänger  
Récepteurs | Receptores  
Microphones | Mikrofone  
Microphones | Micrófonos



Reset  
Zurücksetzen  
Réinitialiser  
Reiniciar







Only Roger transmitters running on software version 4.x are compatible with Roger Touchscreen Mic.

Nur Roger Sender, die über die Software-Version 4.x verfügen, sind mit dem Roger Touchscreen Mic kompatibel.

Seuls les émetteurs Roger ayant la version 4.x ou plus élevée sont compatibles avec Roger Touchscreen Mic.

Sólo emisores Roger que utilizan la versión de software 4.x y la siguientes son compatibles con Roger Touchscreen Mic.

Operating conditions:

Betriebsbedingungen:

0° to +45° Celsius

Conditions de fonctionnement:

32° to +113° Fahrenheit

Condiciones de funcionamiento:

<95%

Relative humidity | relative Luftfeuchtigkeit | humidité relative | humedad relativa



>8 h



Waste Electrical and Electronic Equipment Directive

Elektro- und Elektronikgeräte-Abfall Richtlinie

Directive déchets d'équipements électriques et électroniques

Instrucciones de Residuos de Aparatos Eléctricos y Electrónicos



CE marking

CE-Kennzeichnung

Marquage CE

Marca CE



Class II



Indoor use



Important to read

Wichtig zu lesen

Important de lire

Importante de leer



ACMA - AUS/NZ



Phonak Communications AG  
Laenggasse 17  
CH-3280 Murten  
Switzerland

[www.phonak.com/phonak-roger](http://www.phonak.com/phonak-roger)

